

Three Phase Brake Motors-Aluminum Frame - PM1ADC112MA4 B3

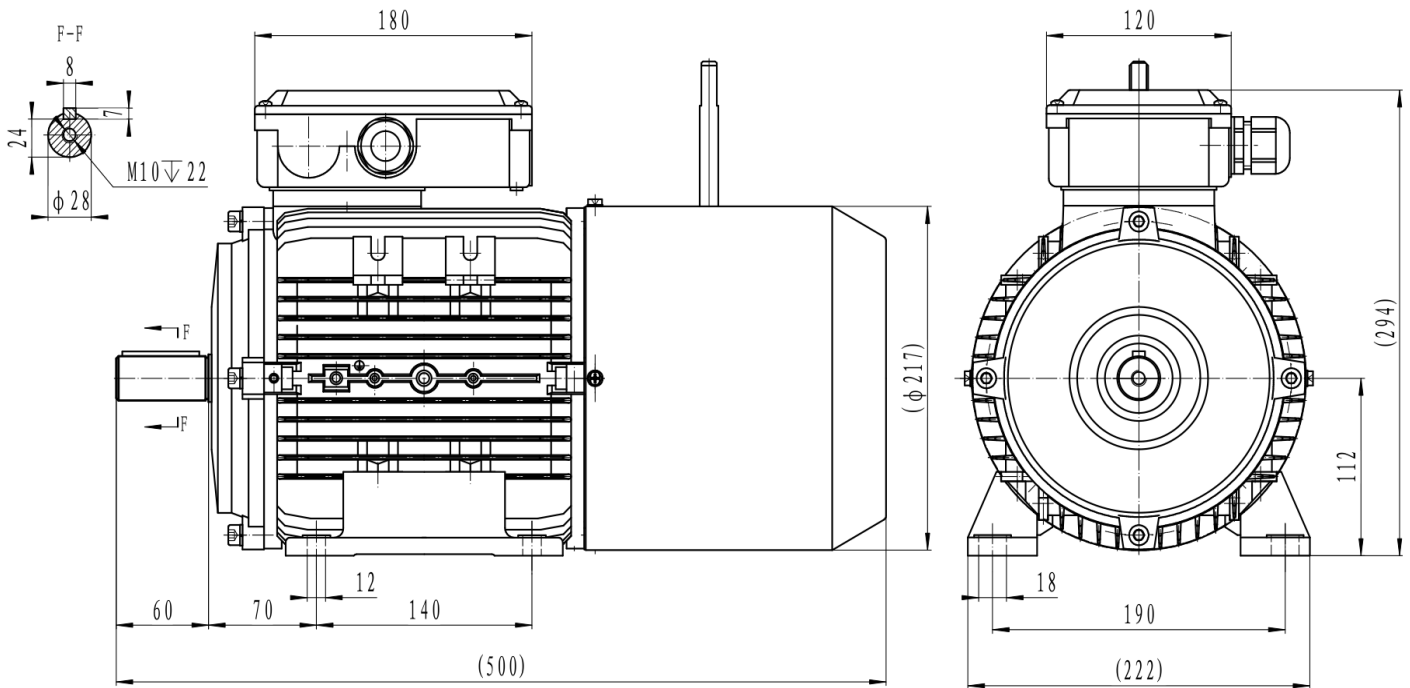

Type	PM1ADC112MA4 PTC
Frame Size	112
Capacity	5.5kW
Speed / Pole	1435 RPM / 4 Pole
Mounting Position	IMB3
Insulation Class	F
Protection Class	IP55
Duty Cycle	S1 Continuous
Temperature Rise Class	B
Ambient temp. (°C)	40°C
Cooling method	IC411 self-Ventilated
Power Factor COS (phi)	83.00%
I-starting / I-nominal	7

Efficiency	IE1 Efficiency
T-starting / T-nominal	2.2
T-max/Tn	2.4
Full Load Torque	36.6Nm
Thermal protection	PTC thermistor
Noise	76 dB
Bearing DE	SKF 6306 ZZC3
Bearing NDE	SKF 6306 ZZC3
Weight (kg)	51.5
Brake	INTORQ BFK457-14
Brake input voltage	400V AC
Brake output voltage	180V DC
Brake torque	60Nm

Electrical data:

Rated Power (kW)	5.5	5.5	6.6	6.6			
Frequency (Hz)	50	50	60	60			
Voltage (V)	380	660	400	690	440	480	830
Speed (RPM)	1435	1435	1435	1435	1722	1722	1722
Connection	Δ	Y	Δ	Y	Δ	Δ	Y
Full load current (A)	11.84	6.82	11.25	6.52	11.84	10.85	6.25