

Three Phase Brake Motors-Aluminum Frame - PM1ADC80A8 B3

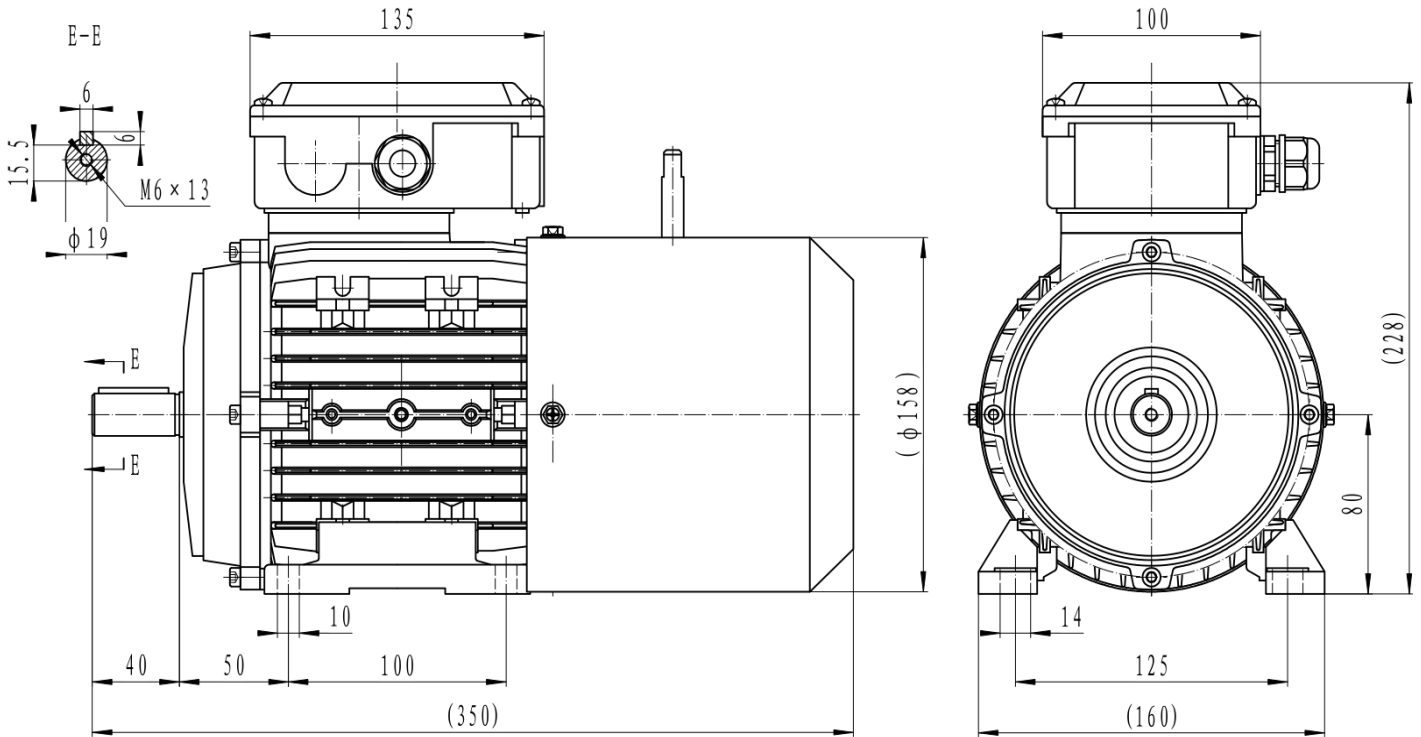

Type	PM1ADC80A PTC
Frame Size	80
Capacity	0.18kW
Speed / Pole	680 RPM / 8 Pole
Mounting Position	IMB3
Insulation Class	F
Protection Class	IP55
Duty Cycle	S1 Continuous
Temperature Rise Class	B
Ambient temp. (°C)	40°C
Cooling method	IC411 self-Ventilated
Power Factor COS (phi)	55.00%
I-starting / I-nominal	5

Efficiency	IE1 Efficiency
T-starting / T-nominal	2
T-max/Tn	2
Full Load Torque	2.53Nm
Thermal protection	PTC thermistor
Noise	63 dB
Bearing DE	SKF 6204 ZZC3
Bearing NDE	SKF 6204 ZZC3
Weight (kg)	12.5
Brake	INTORQ BFK457-08
Brake input voltage	230V AC
Brake output voltage	103V DC
Brake torque	8Nm

Electrical data:

Rated Power (kW)	0.18		0.18		0.22		0.22	
Frequency (Hz)	50		50		60		60	
Voltage (V)	220	380	230	400	250	440	265	460
Speed (RPM)	680	680	680	680	816	816	816	816
Connection	△	Y	△	Y	△	Y	△	Y
Full load current (A)	1.68	0.98	1.61	0.93	1.68	0.98	1.61	0.93