

Three Phase Brake Motors-Aluminum Frame - PM1ADC90L8 B3

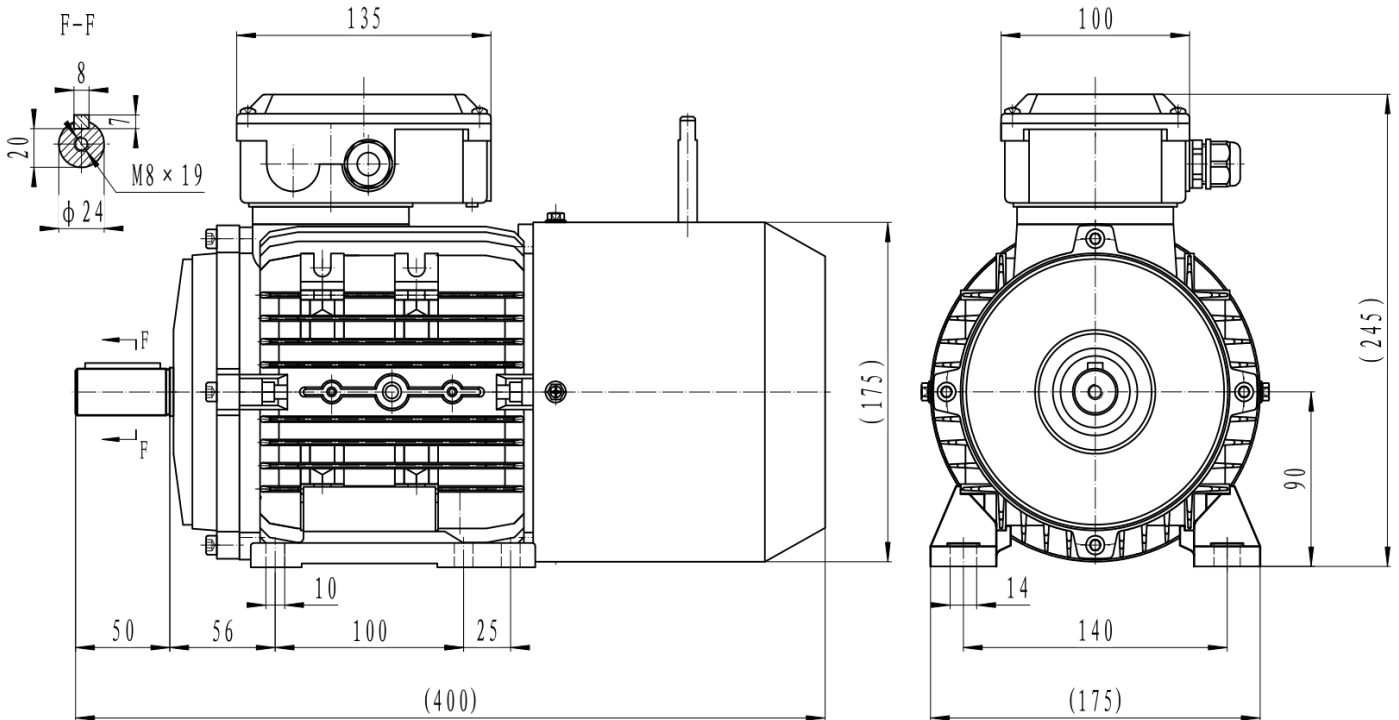

Type	PM1ADC90L8 PTC
Frame Size	90
Capacity	0.55kW
Speed / Pole	700 RPM / 8 Pole
Mounting Position	IMB3
Insulation Class	F
Protection Class	IP55
Duty Cycle	S1 Continuous
Temperature Rise Class	B
Ambient temp. (°C)	40°C
Cooling method	IC411 self-Ventilated
Power Factor COS (phi)	61.00%
I-starting / I-nominal	5

Efficiency	IE1 Efficiency
T-starting / T-nominal	2
T-max/Tn	2
Full Load Torque	7.5Nm
Thermal protection	PTC thermistor
Noise	58 dB
Bearing DE	SKF 6205 ZXC3
Bearing NDE	SKF 6204 ZXC3
Weight (kg)	22.5
Brake	INTORQ BFK457-08
Brake input voltage	230V AC
Brake output voltage	103V DC
Brake torque	16Nm

Electrical data:

Rated Power (kW)	0.55		0.55		0.66		0.66	
Frequency (Hz)	50		50		60		60	
Voltage (V)	220	380	230	400	250	440	265	460
Speed (RPM)	700	700	700	700	840	840	840	840
Connection	Δ	Y	Δ	Y	Δ	Y	Δ	Y
Full load current (A)	3.76	2.17	3.59	2.07	3.76	2.17	3.59	2.07